

lightstar®

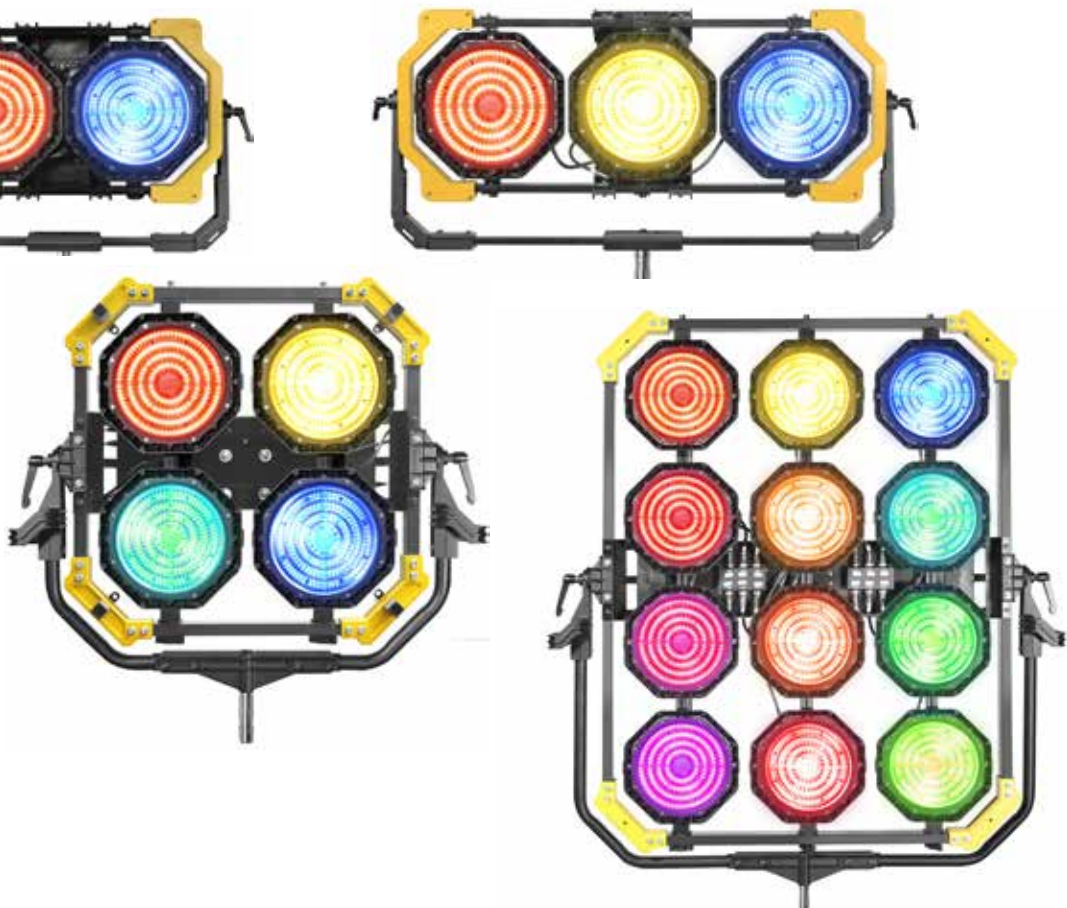

LUXED P Series
User Manual

User Manual

Version: 1. Dezember 2022, 10:58 AM

Lightstar Lights
info@lightstar-lights.com

■ Table of Contents

General Introduction	1
General Characteristics	1
LUXED-P2 – Technical Information	2
LUXED-P3 – Technical Information	3
LUXED-P4 – Technical Information	4
LUXED-P6 – Technical Information	5
LUXED-P9 – Technical Information	6
LUXED-P12 – Technical Information	7
Operational Instructions	9
DMX Control	11
Notice and Maintenance	13
Service Warranty Ordinance	14

■ General Introduction

The Lightstar LUXED P Series are RGBWW LED spotlights, optimized for heat dissipation and with an all new optical design. By using RGBWW high-quality LED's the spectral light distribution is even more continuous, resulting in accurate colors. The LUXED Series has a high output of power and can be used to substitute old Dyno tungsten lights, which need a lot more power. Also the ability to change the color and color temperature is a huge advantage to the original Dyno lights.

The original innovator of the LUXED series has been widely recognized in the market especially in the film and television industry.

■ General Characteristics

- modular design
- high quality bi-color light, CRI ≥ 95
- brightness adjustable from 0 - 100%
- color temperature adjustable between 2400K and 10000K
- 360° adjustable panchromatic hue
- luminous flux output stays relatively stable when temperature is adjusted
- Ability to change between Spot and Flood in Menu
- supports DMX512 protocol
- LCD software control, easy to operate
- DC power input (for battery operation or via mains power supply)
- adjustable frequency from 1Hz to 50Hz
- no UV output
- lamp and power-supply are easy to maintain
- patented optical lens design

■ LUXED-P2 – Technical Information

SKU:	LUXED-P2
Description:	RGBWW LED Spotlight
Power:	320W
Material:	Aluminium casting
Cooling:	Head: passive, Ballast active
Color Temperature:	2400-10000K
Dimming:	0-100%
CRI:	≥ 95
TLCI:	> 90
AC Input:	100-240V AC via PowerCon
DC Input:	48V DC SpeakOn
Control:	DMX In- & Output (5-Pin XLR socket) Wireless DMX (LumenRadio, Bluetooth)
Frequency:	1-50Hz
IP Class:	IP20
Dimensions:	763 x 563 x 172mm
Weight:	8.8 kg

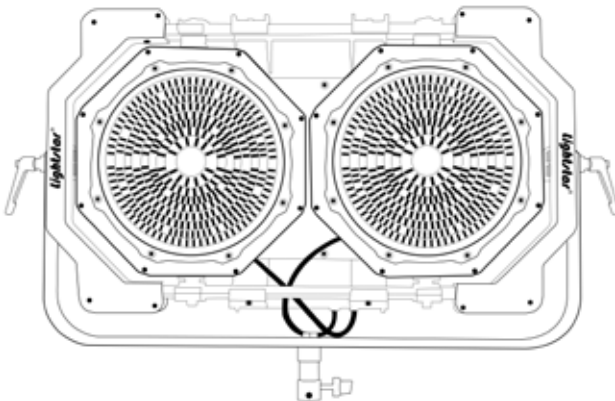

■ LUXED-P3 – Technical Information

SKU:	LUXED-P3
Description:	RGBWW LED Spotlight
Power:	480W
Material:	Aluminium casting
Cooling:	Lamphead: passive, Ballast: active
Color Temperature:	2'400-10'000K
Dimming:	0-100%
CRI:	≥ 95
TLCI:	> 90
AC Input:	100-240V AC via PowerCon
DC Input:	48V DC via SpeakOn
Control:	DMX In- & Output (5-Pin XLR socket) Wireless DMX (LumenRadio) Bluetooth
Frequency:	1-50Hz
IP Class:	IP20
Dimensions:	1048 x 563 x 172mm
Weight:	11.8 kg

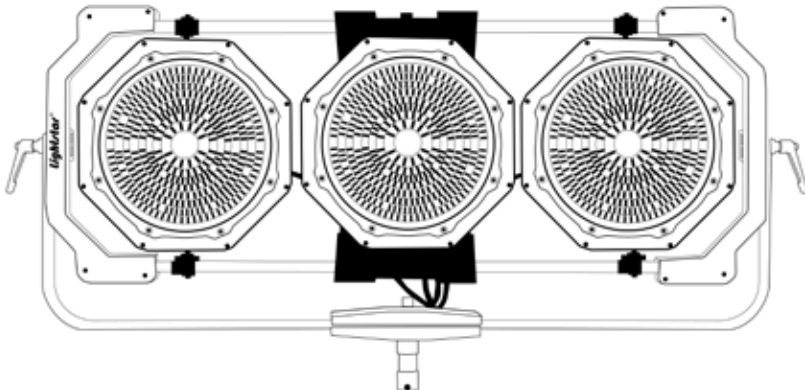

■ LUXED-P4 – Technical Information

SKU:	LUXED-P4
Description:	RGBWW LED Spotlight
Power:	640W
Material:	Aluminium casting
Cooling:	Lamphead: passive, Ballast: active
Color Temperature:	2'400-10'000K
Dimming:	0-100%
CRI:	≥ 95
TLCI:	> 90
AC Input:	100-240V AC via PowerCon
DC Input:	48V DC via SpeakOn
Control:	DMX In- & Output (5-Pin XLR socket) Wireless DMX (LumenRadio) Bluetooth
Frequency:	1-50Hz
IP Class:	IP20
Dimensions:	945 x 910 x 216 mm
Weight:	24 kg

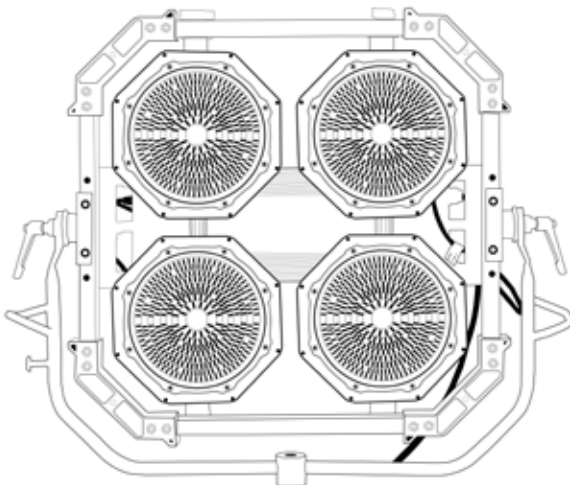

■ LUXED-P6 – Technical Information

SKU:	LUXED-P6
Description:	RGBWW LED Spotlight
Power:	960W
Material:	Aluminium casting
Cooling:	Active
Color Temperature:	2'400-10'000K
Dimming:	0-100%
CRI:	≥ 95
TLCI:	> 90
AC Input:	100-240V AC via PowerCon
Control:	DMX In- & Output (5-Pin XLR socket) Wireless DMX (LumenRadio) Bluetooth
Frequency:	1-50Hz
IP Class:	IP20
Dimensions:	1256 x 910 x 216mm
Weight:	33 kg

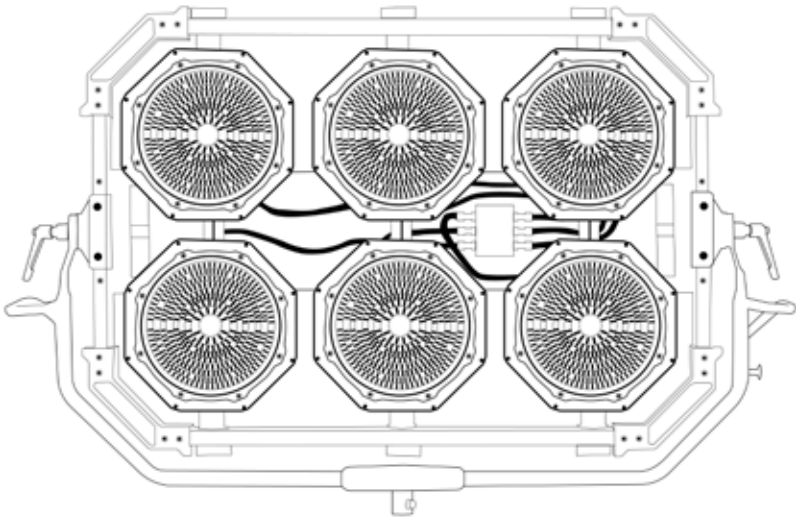

■ LUXED-P9 – Technical Information

SKU:	LUXED-P9
Description:	RGBWW LED Spotlight
Power:	1440W
Material:	Aluminium casting
Cooling:	Active
Color Temperature:	2'400-10'000K
Dimming:	0-100%
CRI:	≥ 95
TLCI:	> 90
AC Input:	100-240V AC via PowerCon
Control:	DMX In- & Output (5-Pin XLR socket) Wireless DMX (LumenRadio) Bluetooth
Frequency:	1-50Hz
IP Class:	IP20
Dimensions:	1256 x 1218 x 216 mm
Weight:	37.5 kg

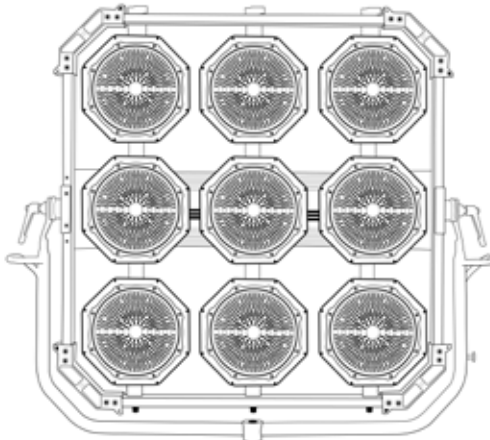

■ LUXED-P12 – Technical Information

SKU:	LUXED-P12
Description:	RGBWW LED Spotlight
Power:	1920W
Material:	Aluminium casting
Cooling:	Active
Color Temperature:	2'400-10'000K
Dimming:	0-100%
CRI:	≥ 95
TLCI:	> 90
AC Input:	100-240V AC PowerCon
Control:	DMX In- & Output (5-Pin XLR socket) Wireless DMX (LumenRadio) Bluetooth
Frequency:	1-50Hz
IP Class:	IP20
Dimensions:	1256 x 1526 x 216mm
Weight:	48 kg

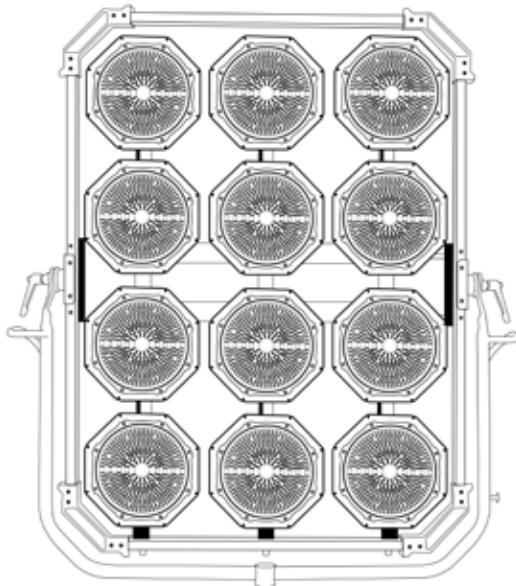

■ Operational Instructions

There are three parts on the control panel: Operating keys, LCD display and the adjustment knob.

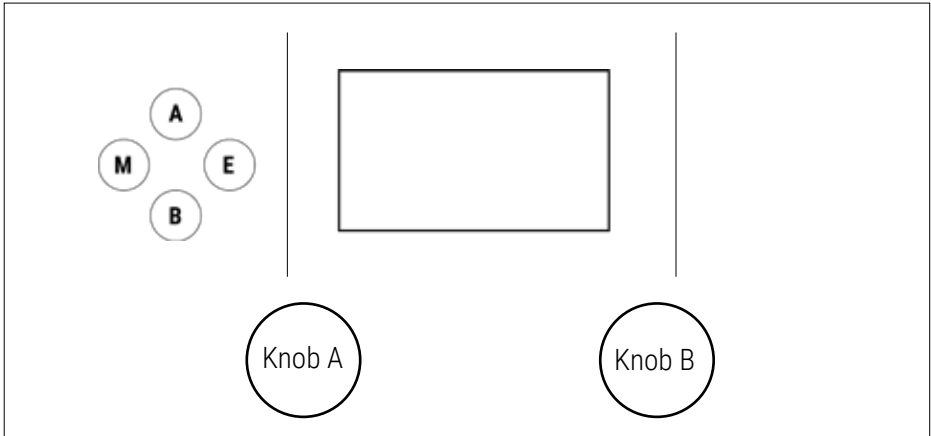

Figure 1 - Control Panel

Operating buttons consist of four keys. Button M is for entering the menu and return to an upper menu level. Button A is to select up button b is for selecting down, button E is to enter.

The adjusting knob A is for adjusting the values, knob b is to select menu and adjust parameters.

Special note: When using accessories such as a diffuser or softbox, switch the light output beam mode to „FLOOD“ - the CCT mode will now show „CCT FLOOD“.

MENU -> FIXTURE SETTINGS -> BEAM MODE -> FLOOD



Intensity - Color Temperature - G/M

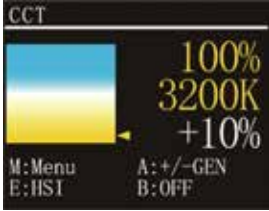

Figure 2 - CCT / Intensity



Figure 3 - +/- Green

When powering on the light, default interface is the CCT setting (wall mode). By turning knob A the intensity can be adjusted. Turn knob B for color temperature. Button A changes to Green/Magenta - adjustable with knob B

Hue - Intensity - Saturation

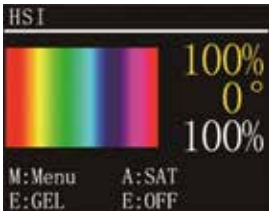

Figure 4 - Intensity/Hue

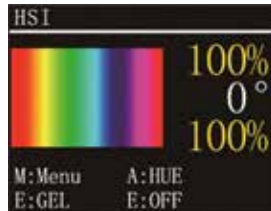

Figure 5 - Saturation

Select button E to change from CCT to HSI mode. As before, knob A is for adjusting the intensity and knob B for Hue parameters. To switch between HUE and SATURATION, push button A.

Color Gels



Figure 6 - GEL Mode

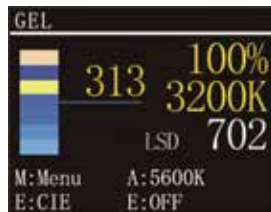

Figure 7 - Intensity/Hue Screen

Push button E to enter GEL mode. Turn knob A to adjust brightness, and knob B to select Color Gel. Select button A to change the color temperature.

CIE - X/Y Coordinates

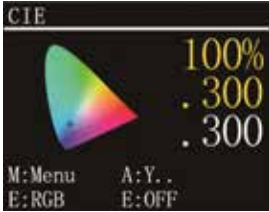

Figure 8 - CIE Screen



Figure 9 - X/Y adjustment

Select button E to enter CIE mode. Turn knob A for brightness, knob B to adjust coordinate parameters. Select button A to switch X/Y coordinates.

RGB

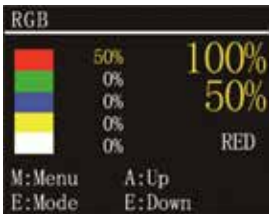

Figure 10 - CCT / Intensity

Select button E to enter RGB mode. Adjust knob A to adjust brightness, adjust knob B to adjust each color. Select color with button A/B.

Light mode



Figure 11 - Main Menu



Figure 12 - Light Mode



Figure 13 - Selection

Select button M, on any interface to enter the MAIN MENU. Select light mode by pushing button E. Optional modes are Rank mode, when using LUXED-P4 / P6 / P9 / P12.

You can now browse through the menu and adjust the parameters here.

But before it is necessary to select the appropriate mode you want to use.

There is also an effect and simulation library. Select button M, on any interface to enter the MAIN MENU. Select light mode by pushing button E. Optional modes are Rank mode, when using LUXED-P4 / P6 / P9 / P12.

You can now browse through the menu and adjust the parameters here. But before it is necessary to select the appropriate mode you want to use.

There is also an effect and simulation library.



Figure 14 - Main Menu



Figure 15 - Main Menu



Figure 16 - Main Menu

Fixture Settings

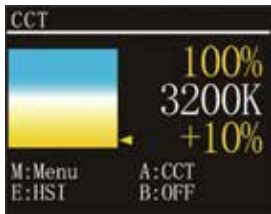

Figure 17 - Fixture Settings

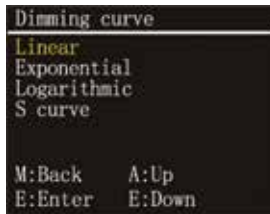

Figure 18 - Dimming

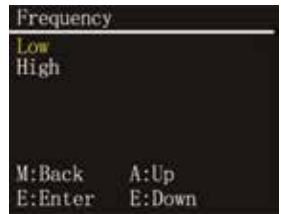

Figure 19 - Main Menu

In menu, select **FIXTURE SETTINGS**, select button E to enter. Up/Down control with button A and E. There you can adjust the parameters of in Figure 17 displayed items.

■ DMX Control

There are two kinds of DMX signal control: Wireless DMX and DMX. By default, DMX is selected. There are 5-Pin XLR In- & Outputs on the console for DMX via cable. For wireless DMX, there is an antenna mounted on the side of the ballast.

DMX512 Data Pinout is as followed:

- Pin 1** Data Link Common GND
- Pin 2** Signal GND
- Pin 3** Signal +
- Pin 4** not used
- Pin 5** not used

DMX Settings



Figure 20 - Main Menu

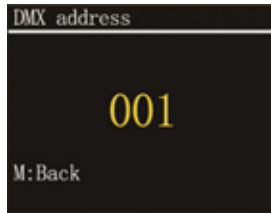

Figure 21 - Address Adjustment

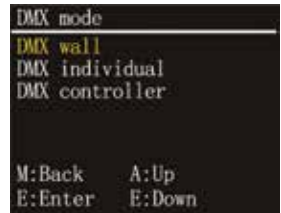

Figure 22 - DMX Mode

In menu screen, select DMX to adjust DMX settings.

DMX WALL MODE: control all units together. Option mode, CCT, HSI, CIE, RTG, GEL, 8-Bit and 16-Bit is optional.
In 8-Bit mode, one function occupies 1 channel
In 16-Bit mode, one function occupies 2 channels

DMX INDIVIDUAL/RANK MODE: control each unit (rank) individually. Option mode, CCT, HSI, CIE, RGB, GEL (all 8-Bit)

DMX CONTROLLER: select DMX controller mode. DMX data is then sent from controller



Figure 23 - DMX Wall



Figure 24 - DMX Individual



Figure 25 - On/Off WDMX

Wireless DMX

Select WDMX Switch to on if using Wireless DMX. Enter by pushing button E.

When using Wireless DMX, make sure that the WDMX button on the ballast is also in ON position! (Figure 25) The WDMX Reset is used to reset / unlink the built-in LumenRadio module.

For DMX Values we put together a chart that can be downloaded from our website. Just go to the „Support“ section and you will find a sheet including all our light fixtures.

1. Click the push button to show current ID settings, increase number if necessary
2. Working Status:
 LED always on : no DMX or no signal
 Red LED flashing: sending
 Green LED flashing: receiving
3. RF Frequency, 126 bands, selected automatically
4. ID code - ---"1-7" group ID code, press „KEY“ to adjust. can only communicate with same ID devices

Setting up the communication:

1. Turn on transmitter and receiver
2. Press „Key“ and set same ID for transmitter and receiver.
3. After sender receives data, it will automatically select the frequency band, sending data.
4. Communication is established

■ Notice and Maintenance

1. LED's operating temperature range must be guaranteed between - 20°C to +40°C. Overheating or undercooling can both reduce the fixtures life span.
2. The product must be placed on a solid, flat and dry surface. The surface temperature should be less than 50°C. Avoid exposure to direct sunlight and operation in an environment with high humidity or explosive gas.
3. Do not beat, knock or shake the light violently or it may influence the normal use of the light.
4. Do not cover lamps with paper, cloth or similar materials that could ignite due to high temperature.
5. Put the lamp in a cool and dry place when you do not use it for a long time.
6. Avoid any flammable liquid, water or metal material entering the machine. Cut off the power supply as soon as this happens.
7. Do not use in dirty and dusty environments and clean them regularly.
8. The technicians must get professional trainings to install, operate or repair LED's.
9. If any equipment from Lightstar doesn't work properly, please get in contact with a Lightstar special repair department or professional technician. Do not disassemble or reassemble the parts by yourself.

■ Service Warranty Ordinance

Customers enjoy a one-year free warranty service as of the date of purchasing our product.

1. If the expiry date of the warranty is reached, our product can still be repaired for an according price.
2. In any of the following circumstances, the product is not repaired free of charge, whether the warranty period expires or not.
 - Damage caused by misuse or abuse, disassembly and non-original parts replacement.
 - Damage caused by natural disasters, unconventional voltage and environmental factors
3. Lightstar will remain in the power of interpretation.
4. Software version modification without further notice.

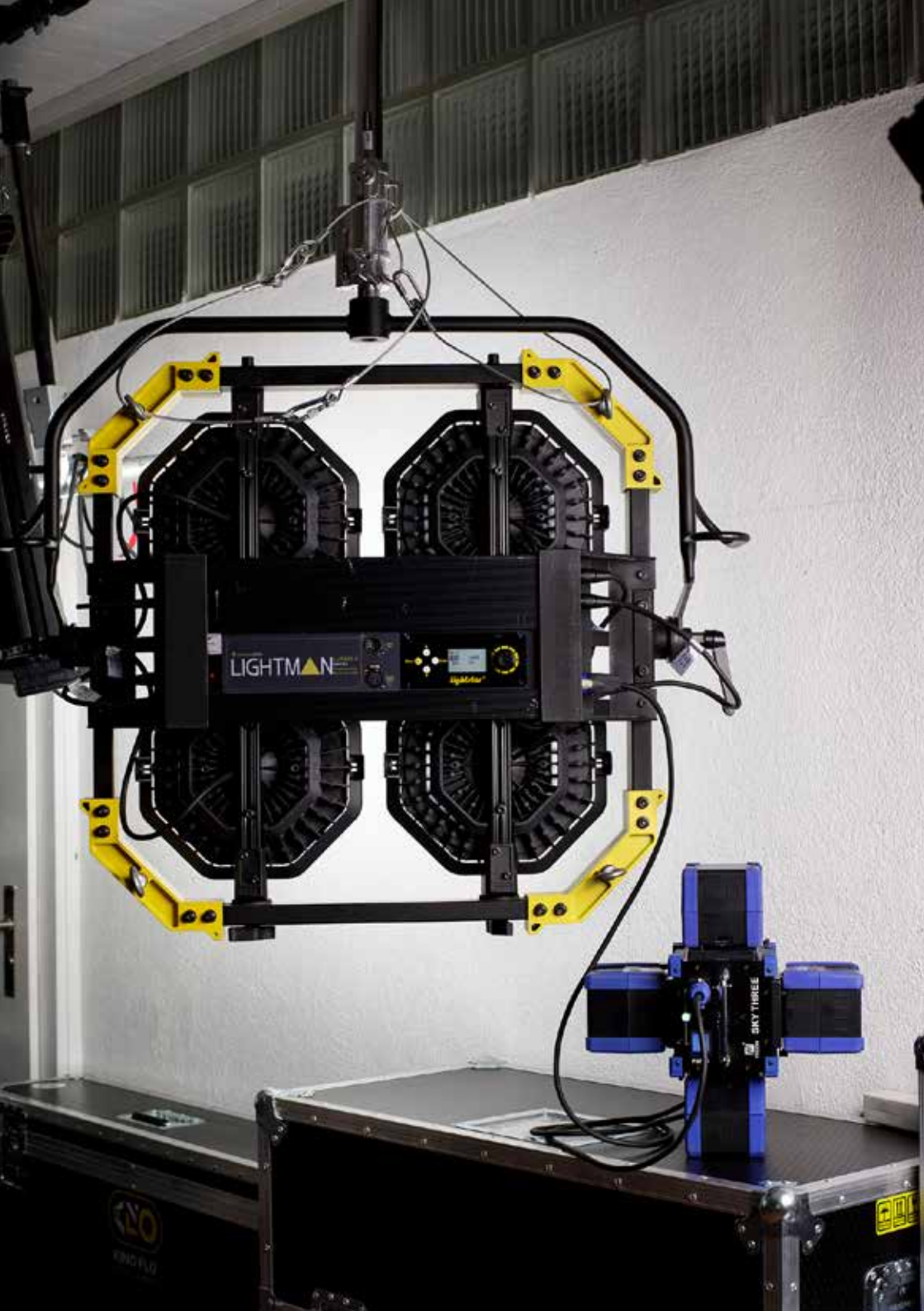

LIGHTMAN

LightMan

SINY THREE